

# TECHNICAL DATASHEET



## WYE TEE 45°

03 Update - 06/2022

### TECHNICAL DATA

Article No	001 317 0045 0075
d (mm)	75
L (mm)	284
le (mm)	72
Z (mm)	185
s (mm)	6,8
Weight (Kg)	0,710
Box Quantity (pcs)	20
Box Dimension (pcs)	55x30x43,5

### IDENTIFICATION OF PRODUCT

D(mm)	75
SDR	11
RAW METARIAL	PE -RT
PRESSURE CLASS	
TRADEMARK	NTG
EXECUTION	Injection Moulded
STANDARD	ISO 22391

### INJECTION MOULDED

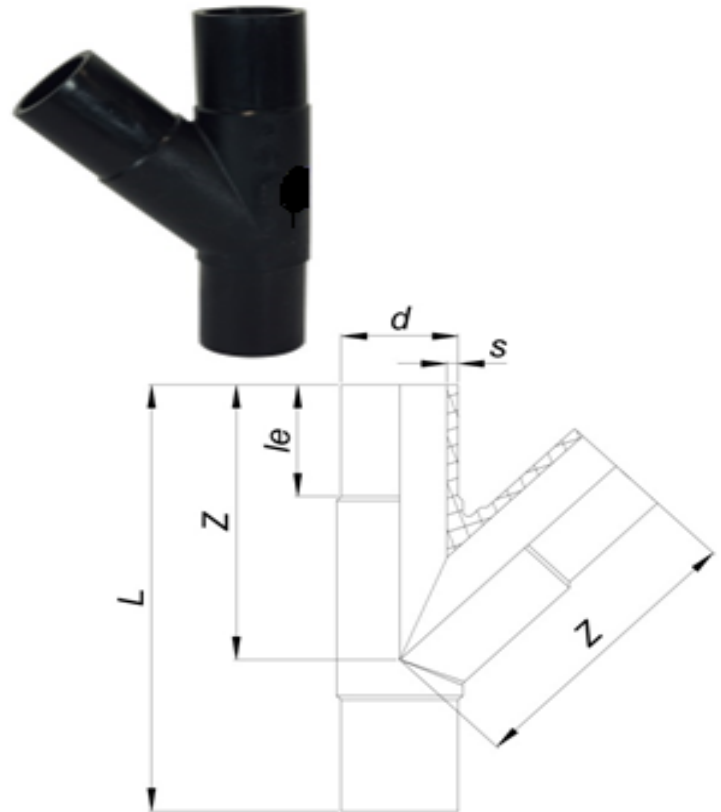

### SPECIFICATION

Long Spigot

Tolerance on diameters and thickness according to the standards. The other dimensions are specialized. Tolerance  $\pm 5\%$ . NTG PLASTIK reserves all the right to change any information without giving prior notice. The production, distribution and utilization of this document without explicit authorization is prohibited.

Fr 161 Rev 00